

PRODUCT DATASHEET

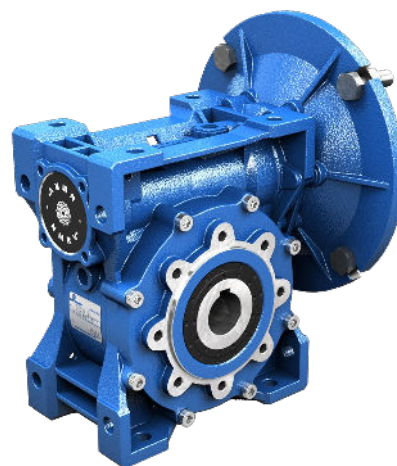

WORMGEARREDUCER

DATE 14.08.2023

CHARACTERISTIC	VALUE
Regulations	No
Worm	PAM NMRV
Size	025
Ratio (i)	60,0
Input Dim.	Ø80x9 (IEC56 B14)
Hollow Output Shaft Dim.	Ø11
Double-Extended Worm Shaft	No
Mounting Position	U
VI-Output Oil Seal	NBR-Nitrile
VI-Input Oil Seal	ACM-Polyacrylate
VI-Output Bearings	Ball Bearings
VI-Lubrication	Synthetic ISO VG320
Paint	Not Painted

Values expressed in [mm]

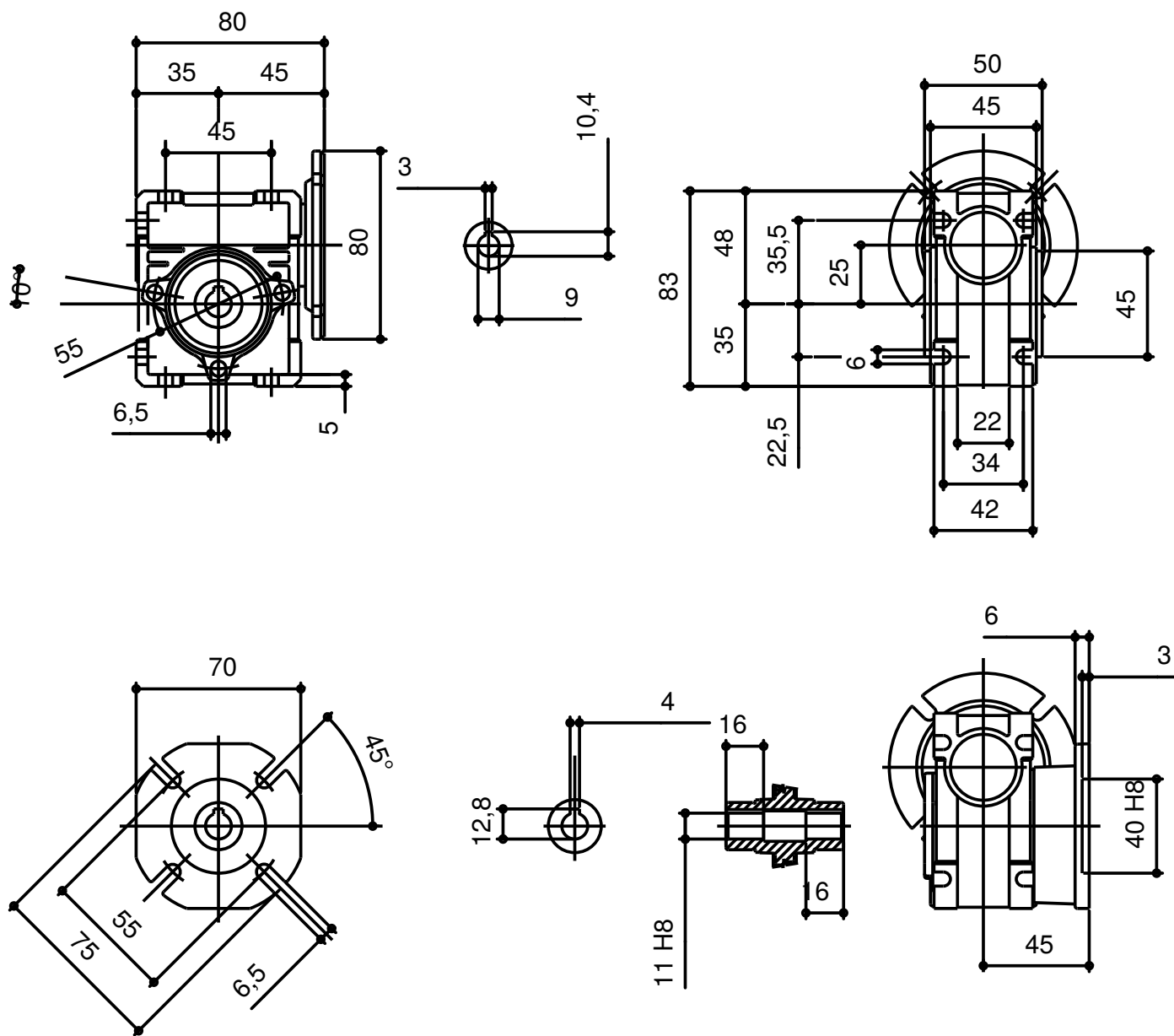

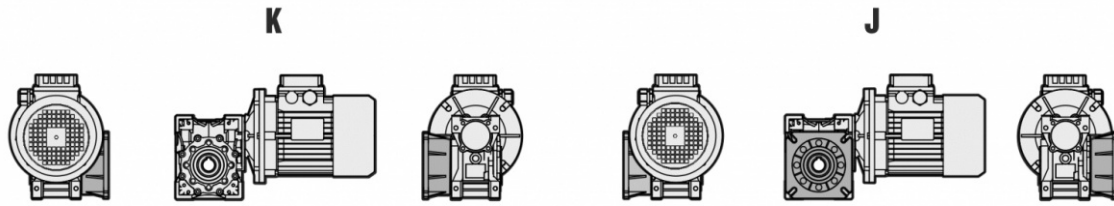

Unless specified otherwise, the reduction unit is supplied with the flange in pos. J referred to position B3.

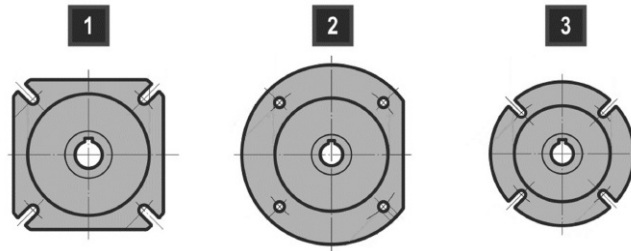

	NMRV - SW	NMRV - SW	NMRV - SW	NMRV-P - SW	NMRV-P - SW	NMRV-P - SW	SW	NMRV-P	NMRV	NMRV
	030	040	050	063	075	090	105	110	130	150
FA	1	1	1	1	1	1	1	1	1	1
FB	-	1	1	1	3	2	1	1	-	-
FC	-	2	2	2	-	3	-	-	-	-
FD	-	2	2	2	-	1	-	-	-	-
FE	-	-	-	3	-	-	-	-	-	-

ISW030

n1 [rpm]	Mn ₂ [Nm]	i	Pn ₁ [kW]	n2 [rpm]	Fr1 [N]	Fr2 [N]
500	19	60,00	0,04	8,0	210	1830
900	17	60,00	0,06	15,0	210	1583
1140	17	60,00	0,07	19,0	210	1463
1400	16	60,00	0,08	23,0	210	1367
1750	15	60,00	0,09	29,0	210	1269
2800	12	60,00	0,10	47,0	126	1085

ISW040

n1 [rpm]	Mn ₂ [Nm]	i	Pn ₁ [kW]	n2 [rpm]	Fr1 [N]	Fr2 [N]
500	48	60,00	0,08	8,0	350	3490
900	41	60,00	0,12	15,0	350	3047
1140	40	60,00	0,14	19,0	350	2816
1400	38	60,00	0,16	23,0	350	2630
1750	36	60,00	0,19	29,0	350	2442
2800	28	60,00	0,21	47,0	350	2087

ISW050

n1 [rpm]	Mn ₂ [Nm]	i	Pn ₁ [kW]	n2 [rpm]	Fr1 [N]	Fr2 [N]
500	87	60,00	0,15	8,0	490	4840
900	76	60,00	0,21	15,0	490	4183
1140	74	60,00	0,25	19,0	490	3866
1400	72	60,00	0,29	23,0	490	3610
1750	68	60,00	0,35	29,0	490	3351
2800	50	60,00	0,36	47,0	490	2865

ISW063

n1 [rpm]	Mn ₂ [Nm]	i	Pn ₁ [kW]	n2 [rpm]	Fr1 [N]	Fr2 [N]
500	180	60,00	0,29	8,0	700	6270
900	153	60,00	0,41	15,0	700	5467
1140	144	60,00	0,47	19,0	700	5053
1400	135	60,00	0,52	23,0	700	4719
1750	128	60,00	0,61	29,0	700	4380
2800	99	60,00	0,70	47,0	700	3745

ISW075

n1 [rpm]	Mn ₂ [Nm]	i	Pn ₁ [kW]	n2 [rpm]	Fr1 [N]	Fr2 [N]
500	301	60,00	0,46	8,0	980	7380
900	247	60,00	0,63	15,0	980	6453
1140	231	60,00	0,73	19,0	980	5964
1400	214	60,00	0,79	23,0	980	5569
1750	201	60,00	0,91	29,0	980	5170
2800	159	60,00	1,08	47,0	980	4421

ISW090

n1 [rpm]	Mn ₂ [Nm]	i	Pn ₁ [kW]	n2 [rpm]	Fr1 [N]	Fr2 [N]
500	440	60,00	0,64	8,0	1270	8180
900	385	60,00	0,93	15,0	1270	7140
1140	369	60,00	1,08	19,0	1270	6599
1400	352	60,00	1,23	23,0	1270	6163
1750	334	60,00	1,44	29,0	1270	5721
2800	245	60,00	1,60	47,0	1270	4891

ISW105

n1 [rpm]	Mn ₂ [Nm]	i	Pn ₁ [kW]	n2 [rpm]	Fr1 [N]	Fr2 [N]
500	729	60,00	0,99	8,0	1270	10320
900	637	60,00	1,45	15,0	1270	9023
1140	606	60,00	1,67	19,0	1270	8339
1400	575	60,00	1,90	23,0	1270	7787
1750	546	60,00	2,23	29,0	1270	7229
2800	430	60,00	2,69	47,0	1270	6181

NRV030

n1 [rpm]	Mn ₂ [Nm]	i	Pn ₁ [kW]	n2 [rpm]	Fr1 [N]	Fr2 [N]
500	19	60,00	0,04	8,0	210	1830
900	17	60,00	0,06	15,0	210	1583
1140	17	60,00	0,07	19,0	210	1463
1400	16	60,00	0,08	23,0	210	1367
1750	15	60,00	0,09	29,0	210	1269
2800	12	60,00	0,10	47,0	126	1085

NRV040

n1 [rpm]	Mn ₂ [Nm]	i	Pn ₁ [kW]	n2 [rpm]	Fr1 [N]	Fr2 [N]
500	48	60,00	0,08	8,0	350	3490
900	41	60,00	0,12	15,0	350	3047
1140	40	60,00	0,14	19,0	350	2816
1400	38	60,00	0,16	23,0	350	2630
1750	36	60,00	0,19	29,0	350	2442
2800	28	60,00	0,21	47,0	350	2087

NRV050

n1 [rpm]	Mn ₂ [Nm]	i	Pn ₁ [kW]	n2 [rpm]	Fr1 [N]	Fr2 [N]
500	87	60,00	0,15	8,0	490	4840
900	76	60,00	0,21	15,0	490	4183
1140	74	60,00	0,25	19,0	490	3866
1400	72	60,00	0,29	23,0	490	3610
1750	68	60,00	0,35	29,0	490	3351
2800	50	60,00	0,36	47,0	490	2865

NRV-P063

n1 [rpm]	Mn ₂ [Nm]	i	Pn ₁ [kW]	n2 [rpm]	Fr1 [N]	Fr2 [N]
500	180	60,00	0,29	8,0	700	6270
900	153	60,00	0,41	15,0	700	5467
1140	144	60,00	0,47	19,0	700	5053
1400	135	60,00	0,52	23,0	700	4719
1750	128	60,00	0,61	29,0	700	4380
2800	99	60,00	0,70	47,0	700	3745

NRV-P075

n1 [rpm]	Mn ₂ [Nm]	i	Pn ₁ [kW]	n2 [rpm]	Fr1 [N]	Fr2 [N]
500	301	60,00	0,46	8,0	980	7380
900	247	60,00	0,63	15,0	980	6453
1140	231	60,00	0,73	19,0	980	5964
1400	214	60,00	0,79	23,0	980	5569
1750	201	60,00	0,91	29,0	980	5170
2800	159	60,00	1,08	47,0	980	4421

NRV-P090

n1 [rpm]	Mn ₂ [Nm]	i	Pn ₁ [kW]	n2 [rpm]	Fr1 [N]	Fr2 [N]
500	440	60,00	0,64	8,0	1270	8180
900	385	60,00	0,93	15,0	1270	7140
1140	369	60,00	1,08	19,0	1270	6599
1400	352	60,00	1,23	23,0	1270	6163
1750	334	60,00	1,44	29,0	1270	5721
2800	245	60,00	1,60	47,0	1270	4891

NRV-P110

n1 [rpm]	Mn ₂ [Nm]	i	Pn ₁ [kW]	n2 [rpm]	Fr1 [N]	Fr2 [N]
500	781	60,00	1,06	8,0	1700	10320
900	682	60,00	1,55	15,0	1700	9023
1140	649	60,00	1,79	19,0	1700	8339
1400	616	60,00	2,03	23,0	1700	7787
1750	585	60,00	2,39	29,0	1700	7229
2800	473	60,00	2,96	47,0	1700	6181

NRV130

n1 [rpm]	Mn ₂ [Nm]	i	Pn ₁ [kW]	n2 [rpm]	Fr1 [N]	Fr2 [N]
500	1070	60,00	1,46	8,0	2100	13500
900	940	60,00	2,11	15,0	2100	11801
1140	920	60,00	2,61	19,0	2100	10907
1400	900	60,00	3,01	23,0	2100	10185
1750	855	60,00	3,58	29,0	2100	9455
2800	640	60,00	3,96	47,0	2100	8084

NRV150

n1 [rpm]	Mn ₂ [Nm]	i	Pn ₁ [kW]	n2 [rpm]	Fr1 [N]	Fr2 [N]
500	1680	60,00	2,26	8,0	2800	18000
900	1440	60,00	3,19	15,0	2800	16133
1140	1440	60,00	4,04	19,0	2800	14911
1400	1260	60,00	4,16	23,0	2800	13924
1750	1197	60,00	4,94	29,0	2800	12926
2800	990	60,00	6,12	47,0	2800	11051

MOUNTING POSITIONS

The mounting position of the gear unit identifies its space orientation. B3 mounting position, as from a technical point of view, ensures lower oil splash, better lubrication and less heating.

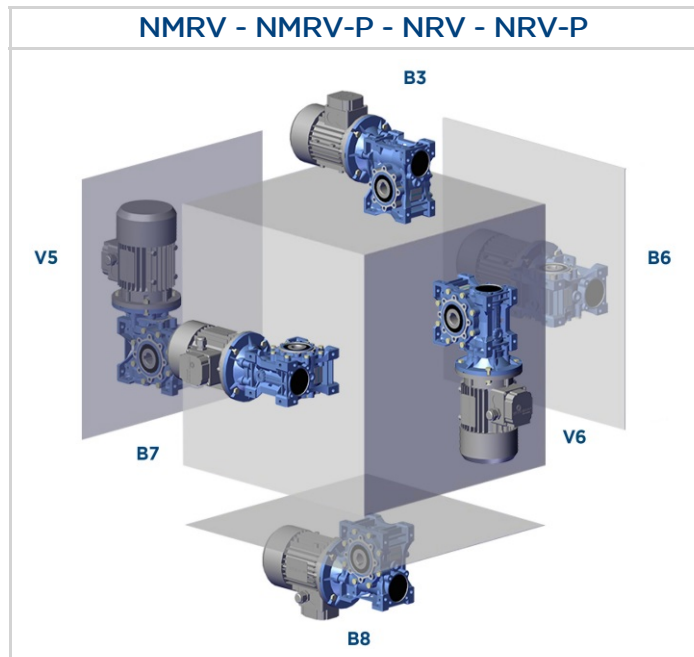

Execution

NMRV/NMRV-P+NMRV/NMRV-P - NRV/NRV-P+NMRV/NMRV-P

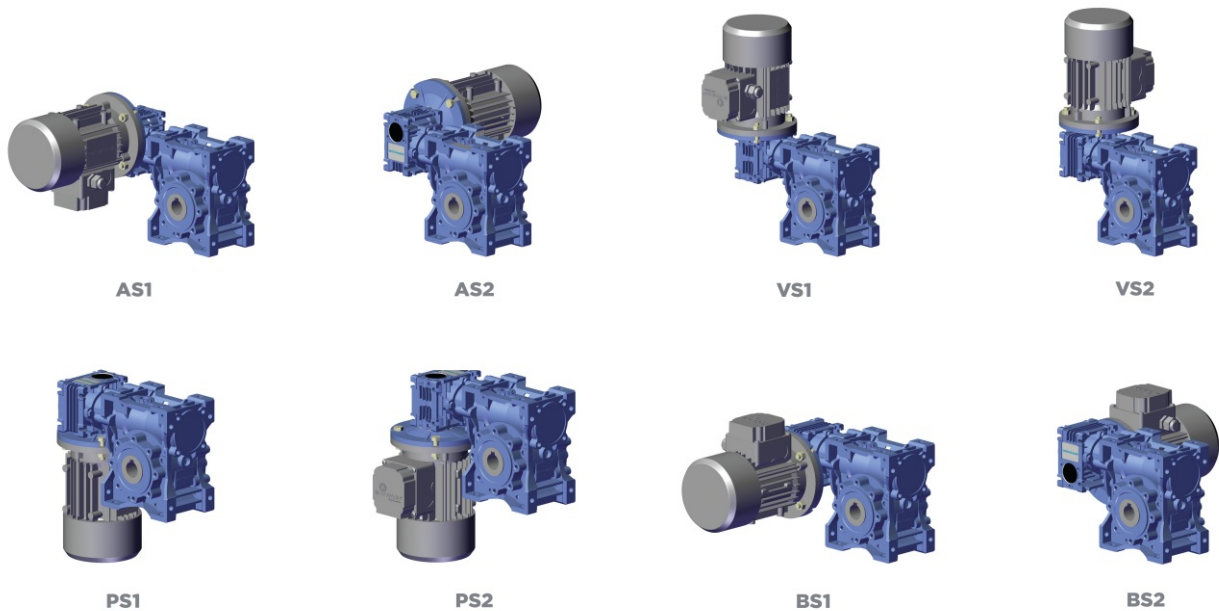

- The gear reducers size 025 - 030 - 040 - 050 - 063 - 075 - 090 - 105 - 110 - 130 - 150 are supplied complete with lubricant for life, synthetic oil, ENI TELIUM VSF. They can be mounted in any position envisaged in the catalogue, except for NMRV-P/SW 090 - 110 and NRV-P/ISW 075-090-110 for which you must to specify the mounting position.
- For sizes 130 and 150 it is necessary to specify the position, otherwise the gear reducers are supplied with the quantity of oil relating to pos. B3.
- Only reduction units 130 and 150 are fitted with breather, level and oil drainage plugs.
- The pre-stage helical modules are supplied complete with life-long lubricant, synthetic oil, ENI TELIUM VSF. Lubrication is separated from that of the worm gear reducers.

It is recommended, after installation, to replace the closed plug used for transportation with the supplied breather plug.

Quantity of oil in litres -

NMRV	025	030	040	050	130	150
B3	0,02	0,04	0,08	0,15	4,5	7
B8					3,3	5,1
B6-B7					3,5	5,4
V5					4,5	7
V6					3,3	5,1

NMRV-P	063	075	090	110
B3	0,33	0,55	1,15	1,6
B8				
B6-B7				
V5				
V6				

SW	030	040	050	063	075	090	105
B3	0,04	0,08	0,15	0,3	0,55	1	1,6
B8							
B6-B7							
V5							
V6							

HW	HW030		HW040	
	NMRV-P063	NMRV-P075	NMRV-P090	NMRV-P110
B3-B6-B7-B8-V5-V6	0,06	0,09	0,11	0,12

H	A31
B3-B5	0,07

NMRV	063	075	090	105	110
B3	0,3	0,55	1	1,6	3
B8					2,2
B6-B7					2,5
V5					3
V6					2,2

DIRECTION OF ROTATION

The worm screw rotation is right-handed.

DIRECTION OF ROTATION - HIGH SPEED SHAFT

NMRV - NRV - SW - ISW



MOUNTING POSITION **B3**

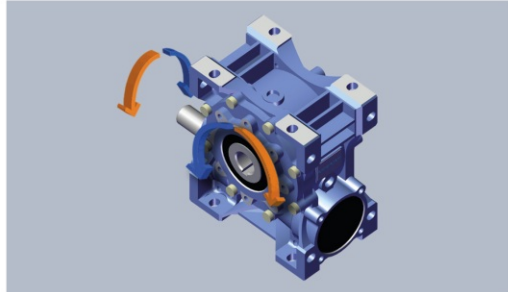

MOUNTING POSITION **B8**

NMRV + NMRV - SW + SW - NRV + NMRV - ISW + SW

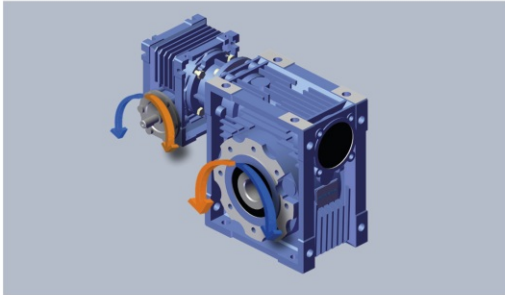

MOUNTING POSITION **AS1**

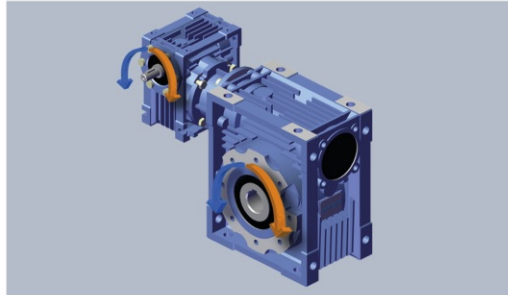

MOUNTING POSITION **BS1**